

4' x 8' x Variable Area Inlet

Table Top

Opening/Ring & Cover per Job
(24" Ring & Cover Depicted)

Height: 14"

Walls: 6"

Approximate

Weight : 3,202.58 lbs

Standard Riser(s)

Height: 1' → 4'

Walls: 6"

Approximate

Weight : 1950 lbs/ft
(Per Vertical Foot)

Hole Specific Base

Height: Up to 4' I.D.

Walls: 6"

Floor: 6"

Approximate

Weight : 11,178 lbs at 4' I.D.

Thin Wall Knockouts/Holes

Holes Shown on Box for
Reference Only.
Holes as Requested.

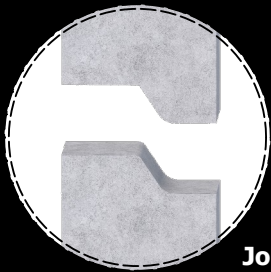

Joint Detail

Specifications:

- Concrete has a 28 day strength of 5,000 psi
- Steel reinforcement is ASTM A615 grade 60
- Load Design is AASHTO HS20-44

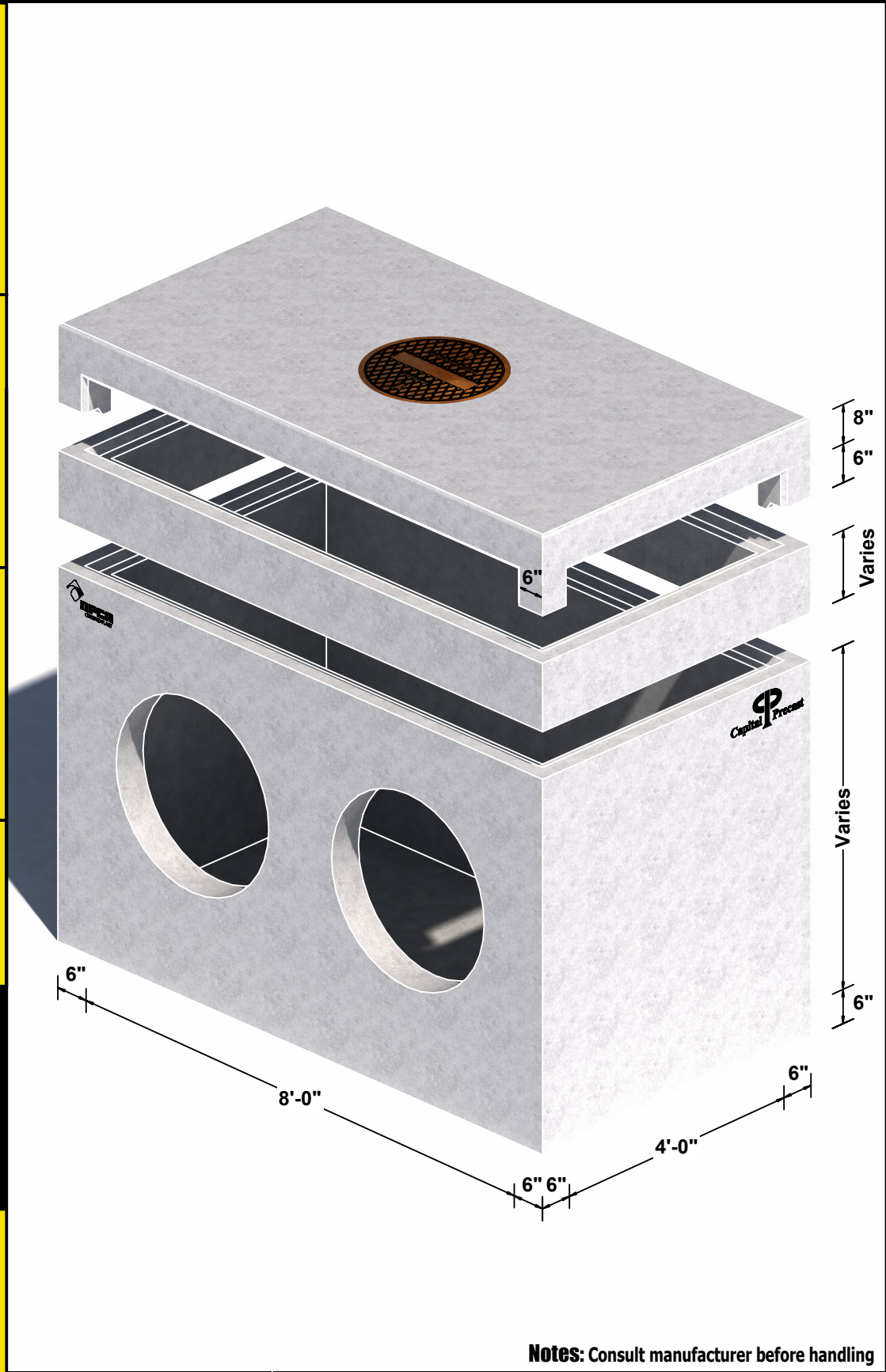

Notes: Consult manufacturer before handling



6905 South Old Bastrop Hwy
San Marcos Texas, 78666
PH: (830) 606-6200
capitalprecastllc.com

4' x 8' x Variable Area Inlet

Job:

Drawn:

JJ

Rev:

Date:

4/21/2026